



**UV80-1**

**FUEL ANTI-SIPHON**

**ULTRA Value**

**Technical specifications**

Product details	
Filler neck type	80mm double bayonet
Device Type	External
Locking method	Snap-off screws
Device material	Zinc-plated steel
Weight	0.58 kg
Flow speed	120 L/min

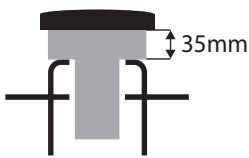

External device

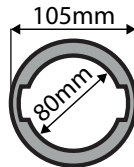

Double bayonet

**Product dimensions (mm)**

Use these dimensions to confirm the product will fit your vehicle

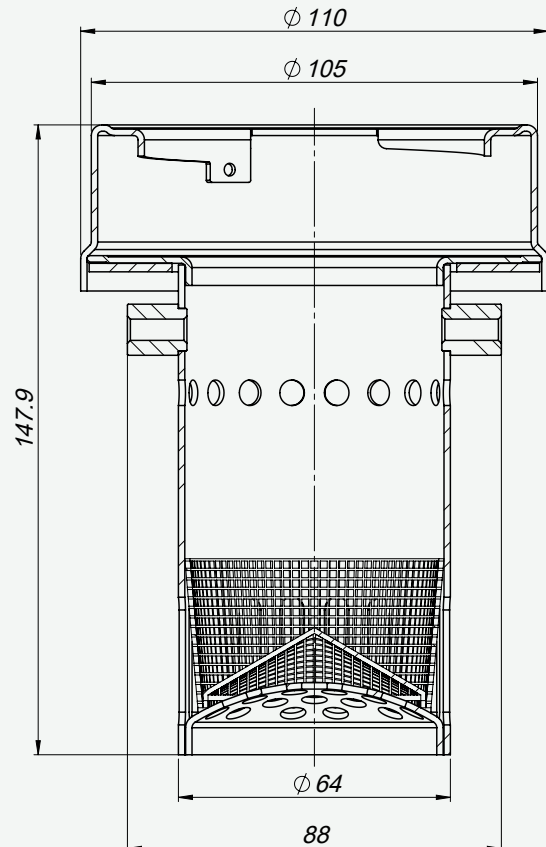
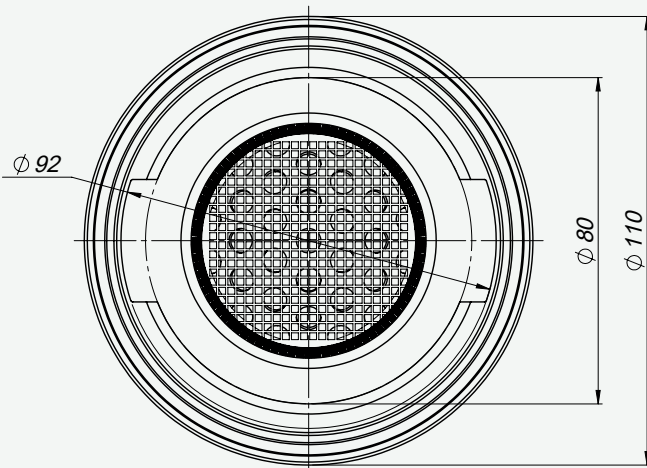

## UV80-1 Vehicle Application List

### Truck vehicles fitted

	Manufacturer	Models
	DAF	CF75, CF85, XF Range
	Dennis Eagle	Refuse truck - Elite 6
	FAW	Some models
	IVECO	Stralis, EuroCargo (metal tank)
	MAN	All models
	Mercedes-Benz	All models (excluding Atego plastic tank)
	Mitsubishi	Canter Fuso some models
	Renault	Most models
	Terberg	Most models
	Volvo	Most models

### Construction vehicles fitted

	Manufacturer	Models
	Atlas	Most models
	Hamm	GRW18, Z520D, HD99
	Hitachi	ZX250
	Hyster	Container handler
	John Deere	Harvester 7450
	Liebherr	Some models
	Sandvik	Some models
<i>For more information on specific vehicles please contact us</i>		

### Other vehicles & machinery

	Manufacturer	Models
	Other	<i>There are more vehicles with the same filler neck, please contact us for more details.</i>